

LOD250

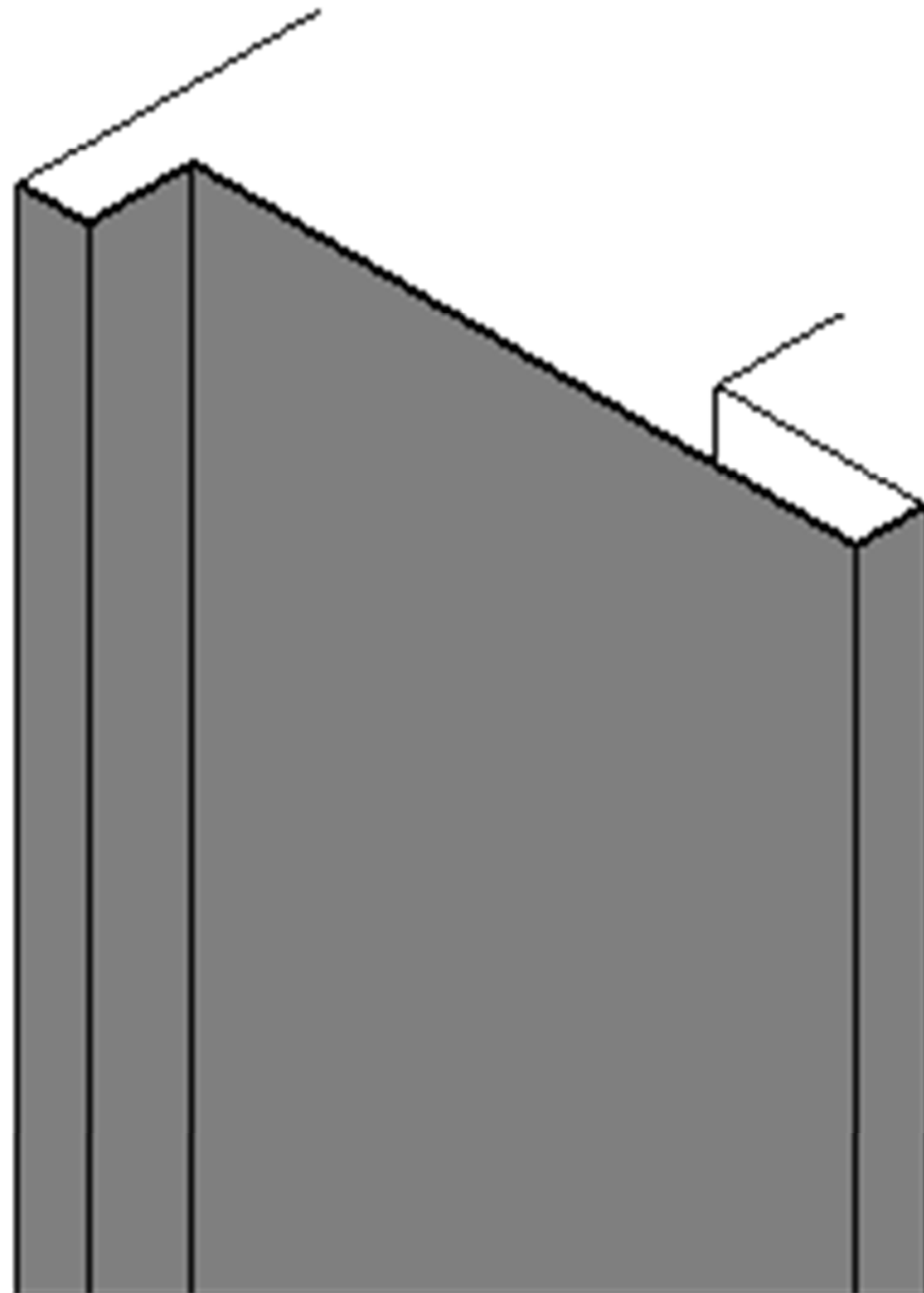

<BIM 製品データ>

SL-250HNC

クリアランス : 250

可動量 X : +172mm -150mm

Y : +150mm -150mm

Z : +30mm -30mm

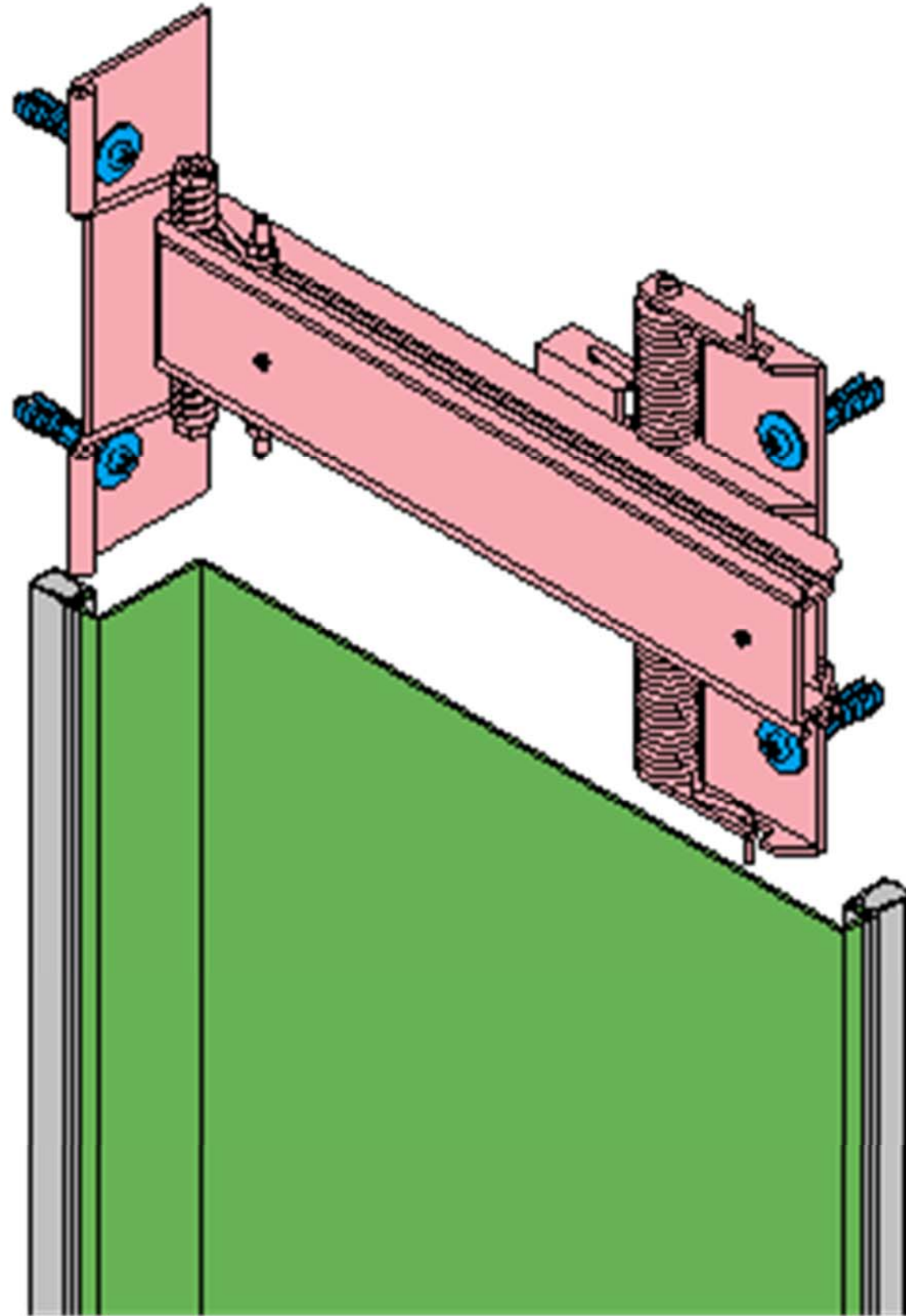

LOD400

■	内壁コーナー	SL-250HNC	種別：アルミ	固定ピッチ： @ ≤ 900 mm	S= 1:2
---	--------	-----------	--------	----------------------	--------

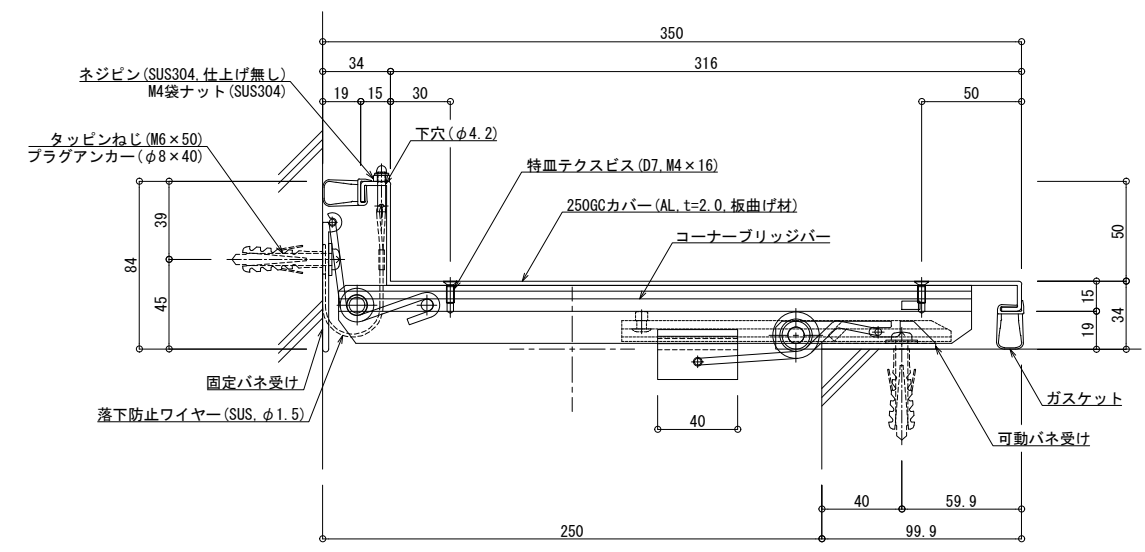

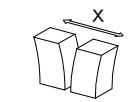
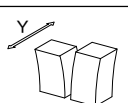
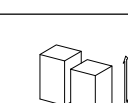
可動図	可動量
	+172mm -150mm
	+150mm -150mm
	+30mm -30mm

制定: 2017.9.20
 改訂: 2023.01.13