

<BIM 製品データ>

SL-250HT

クリアランス : 250

可動量 X : +225mm -112mm

Y : +150mm -150mm

Z : +30mm -30mm

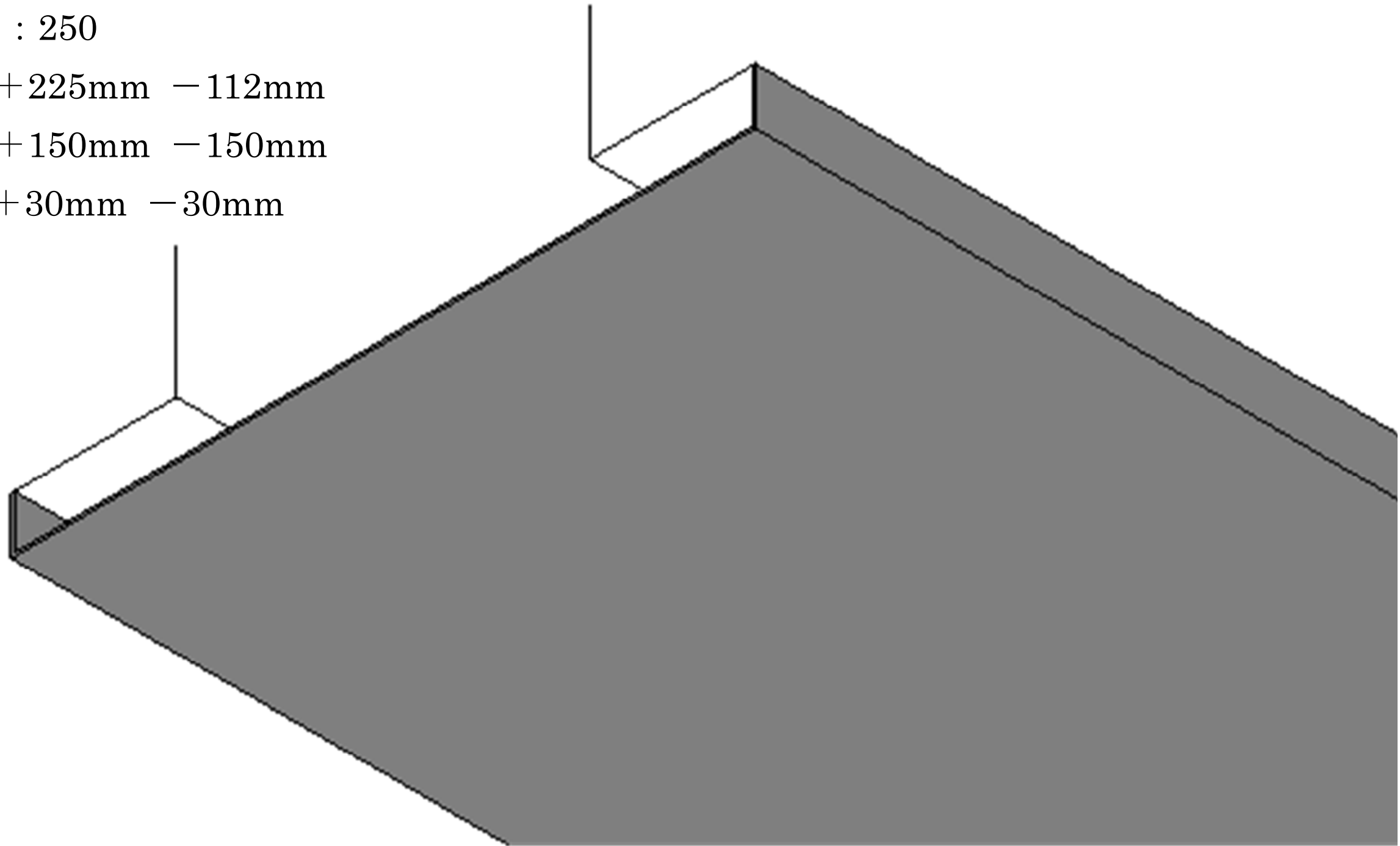

LOD250

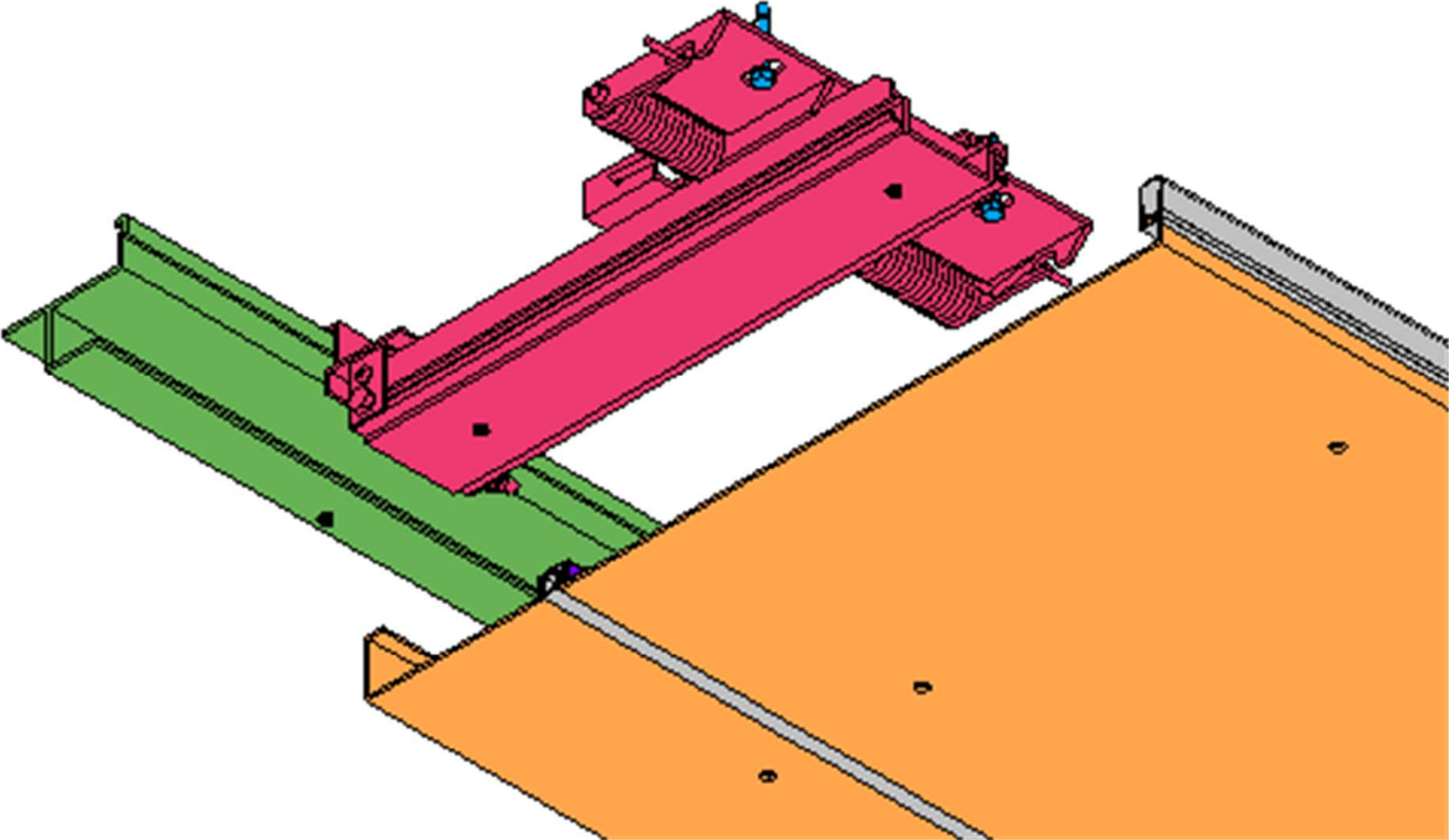

LOD400

天井 - 天井 SL-250HT

種別：アルミ

定尺2m

固定ピッチ：@ ≤ 850 mm

定尺3m

固定ピッチ：@ ≤ 900 mm

S= 1:2

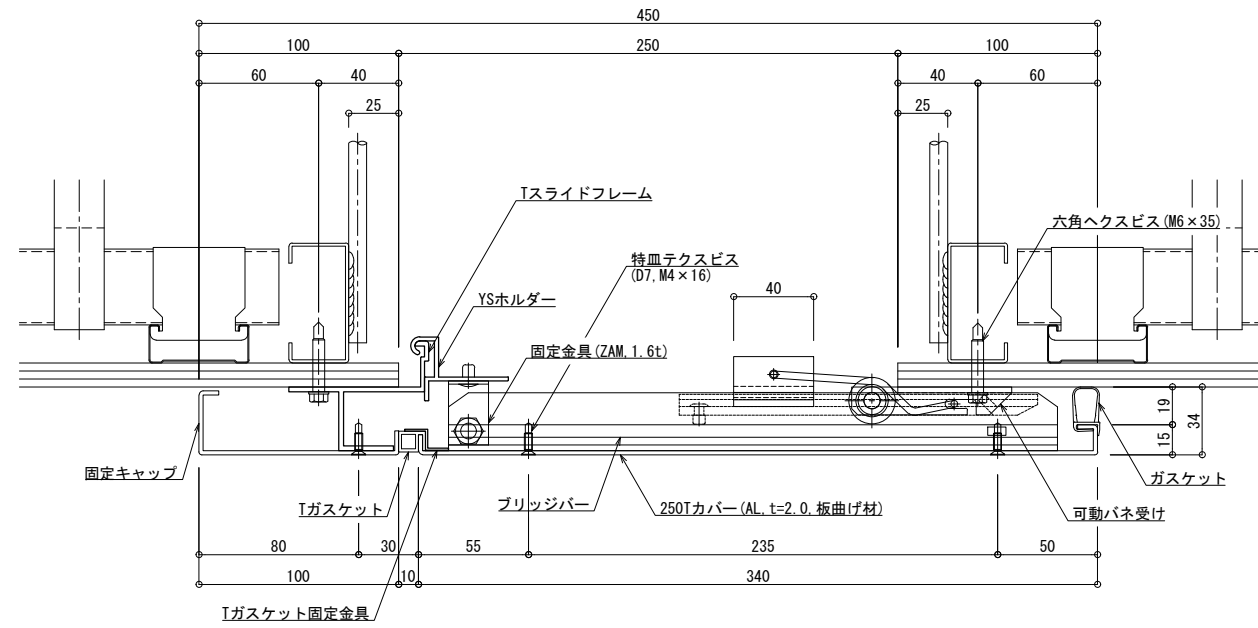

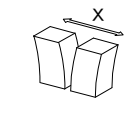
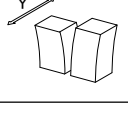
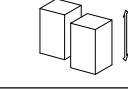
可動図	可動量
	+225mm -112mm
	+150mm -150mm
	+30mm -30mm

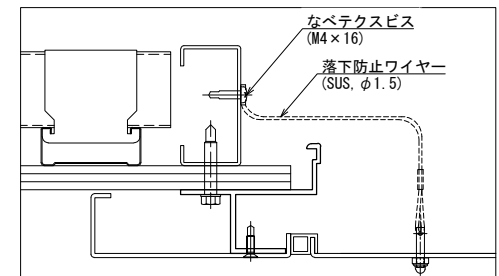

制定: 2017.9.20 改訂: 2023.03.31