

LOD250

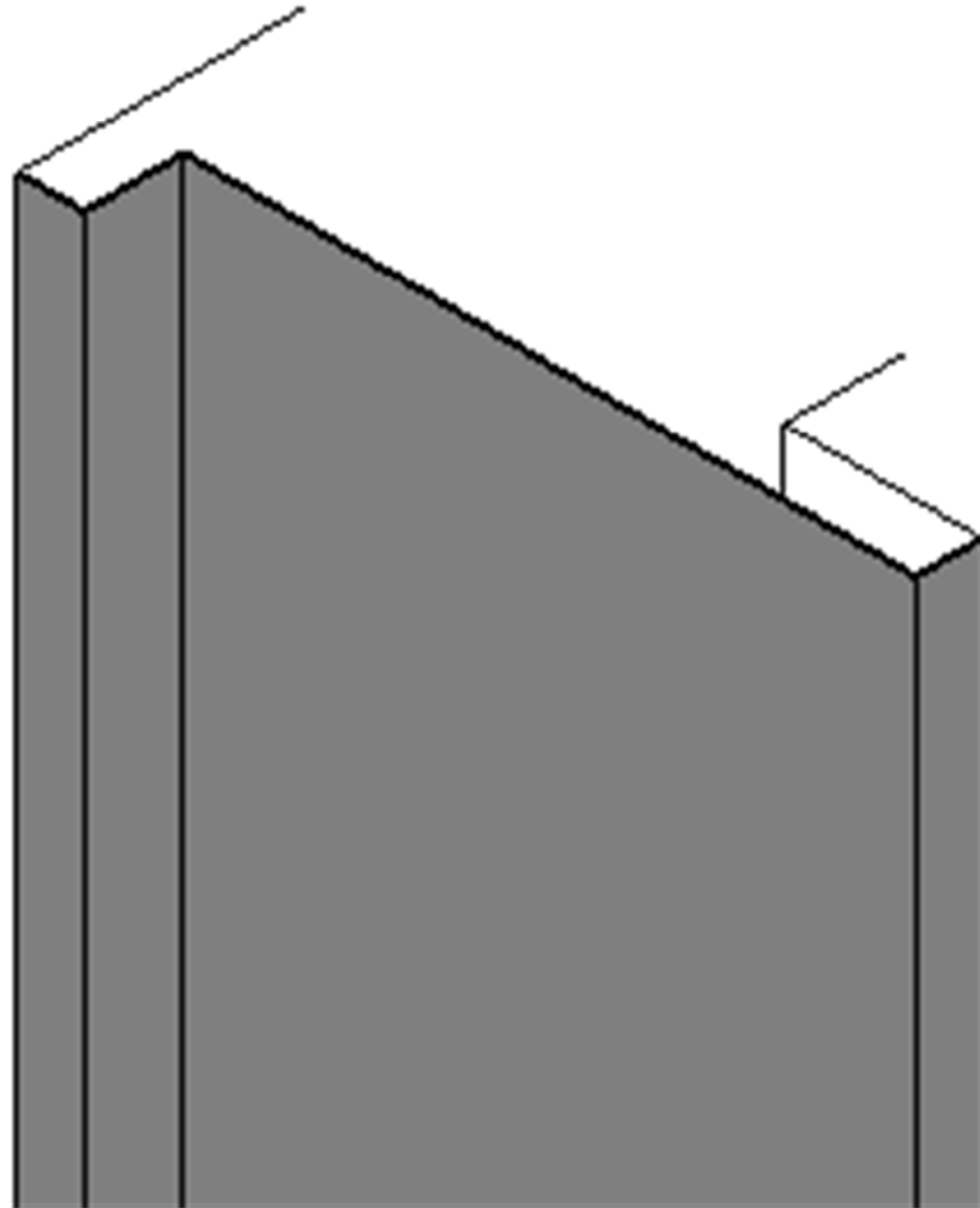

<BIM 製品データ>

SL-300HNC

クリアランス : 300

可動量 X : +192mm -200mm

Y : +180mm -180mm

Z : +30mm -30mm

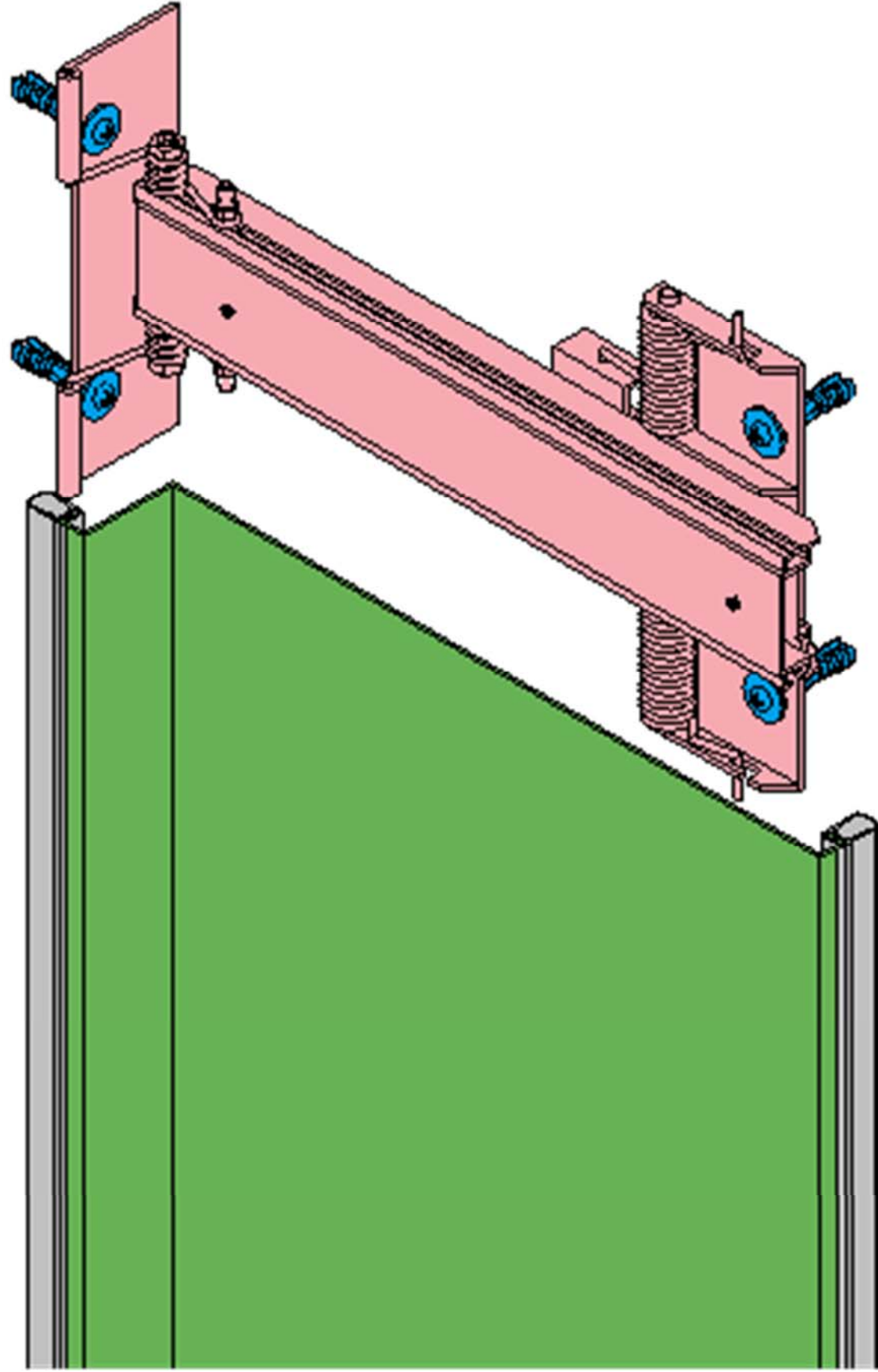

LOD400

■	内壁コーナー	SL-300HNC	種別：アルミ	固定ピッチ： @ ≤ 900 mm	S= 1:2
---	--------	-----------	--------	----------------------	--------

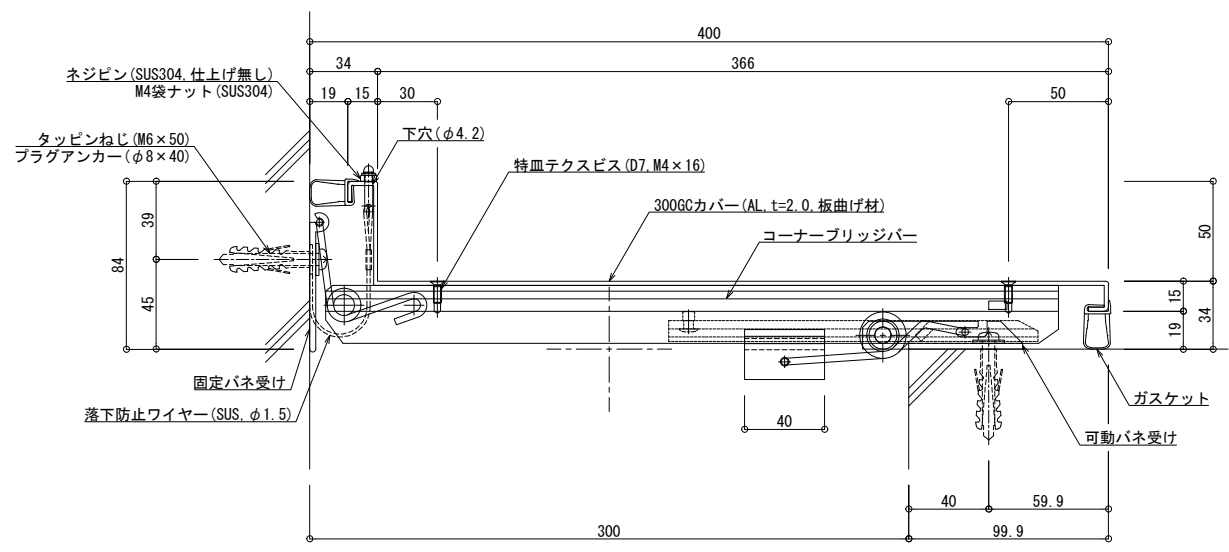

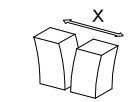
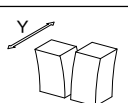
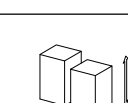
可動図	可動量
	+192mm -200mm
	+180mm -180mm
	+30mm -30mm

制定: 2017.9.20
 改訂: 2023.01.13