

LOD250

<BIM 製品データ>

SL-500HGC 耐火仕様

クリアランス : 500

可動量 X : +287mm -289mm

Y : +300mm -300mm

Z : +30mm -30mm

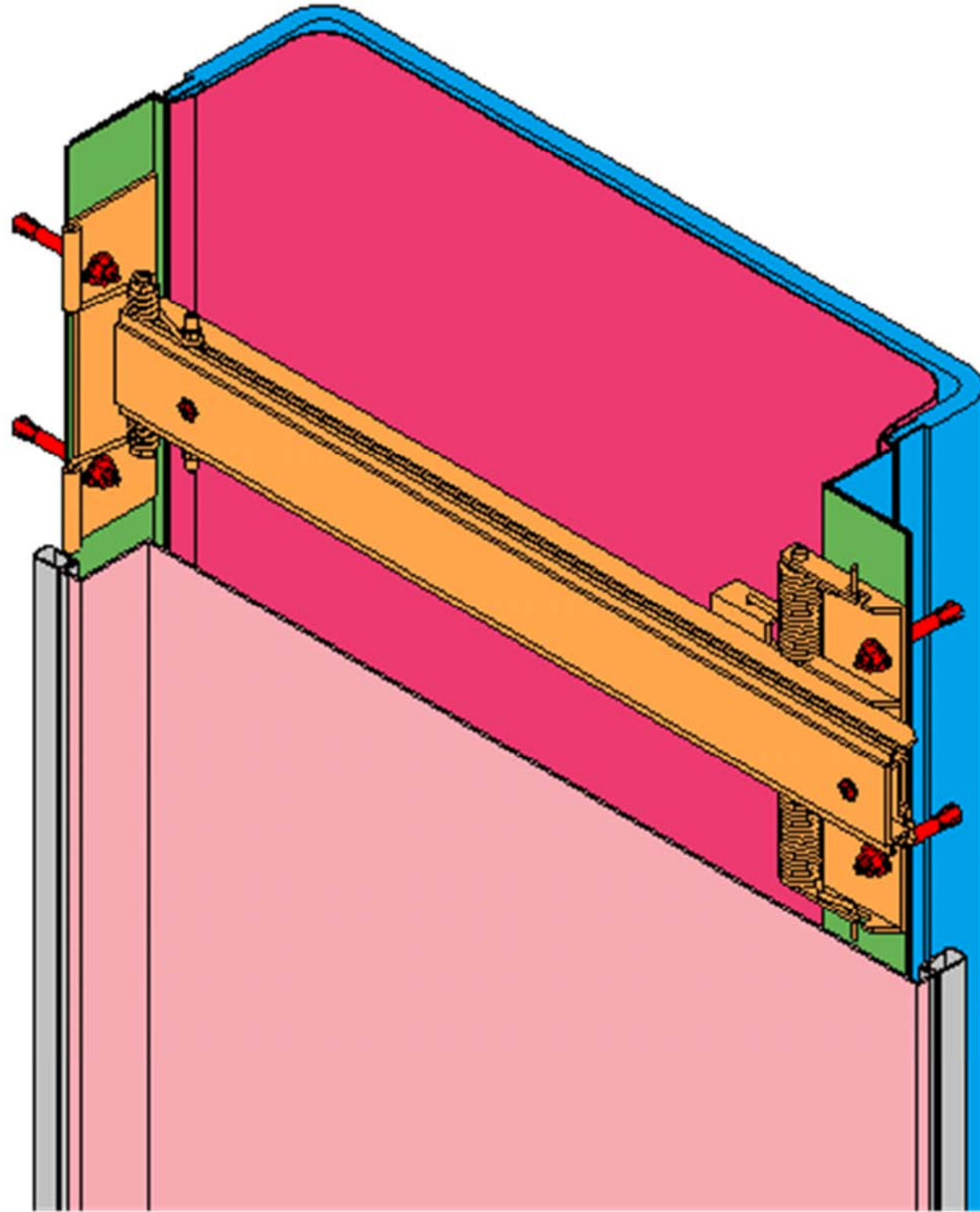

LOD400

■	外壁コーナー	SL-500HGC (耐火仕様) 12.5mm	種別: アルミ	定尺2m	定尺3m	S= 1:2
				固定ピッチ: @ ≤ 850 mm	固定ピッチ: @ ≤ 900 mm	

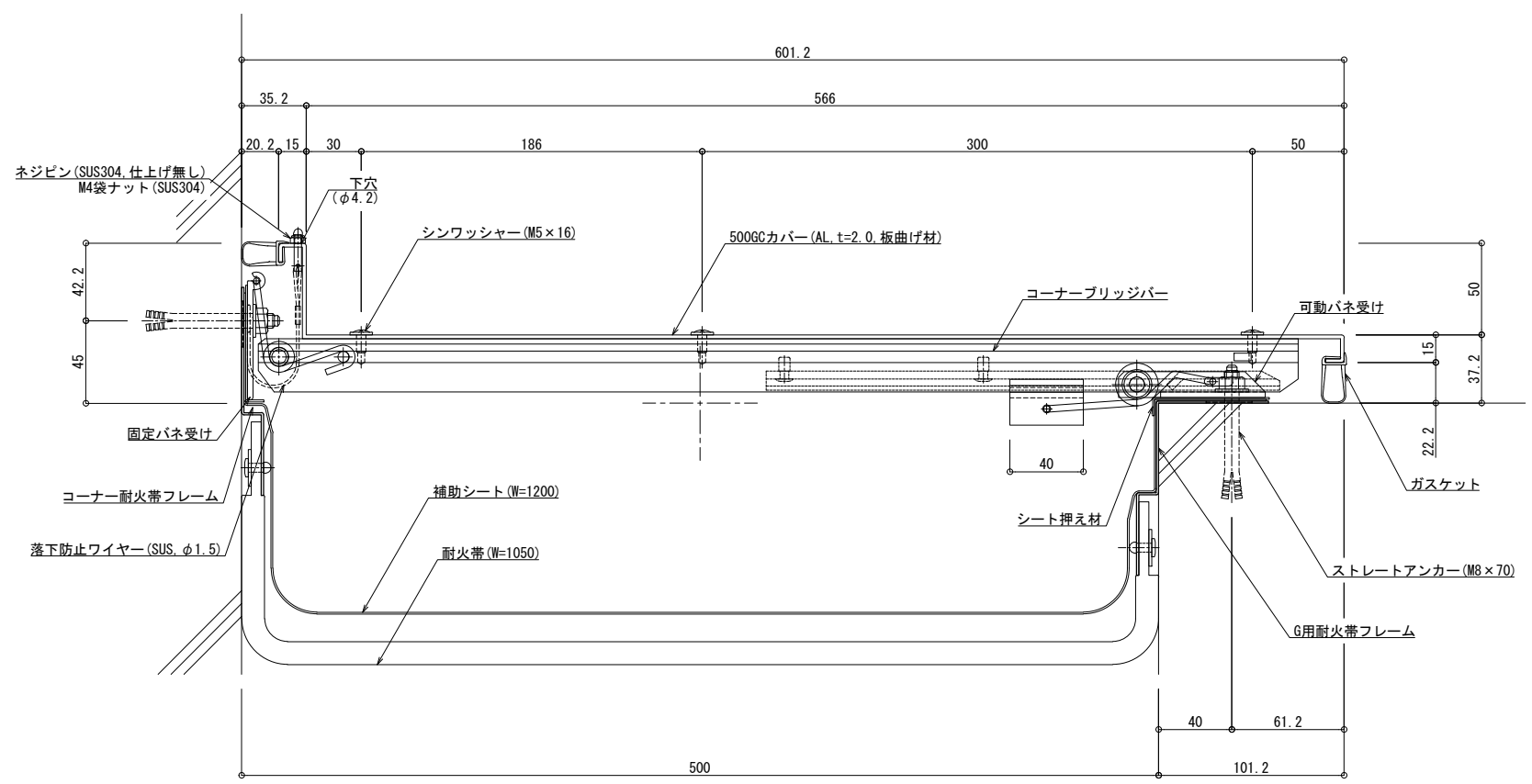

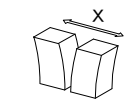
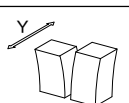
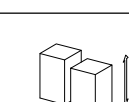
可動図	可動量
	+287mm -289mm
	+300mm -300mm
	+30mm -30mm

制定: 2017.9.20  
 改訂: 2023.03.31