

<BIM 製品データ>

SL-550HTC

クリアランス : 550

可動量 X : +375mm -275mm

Y : +330mm -330mm

Z : +30mm -30mm

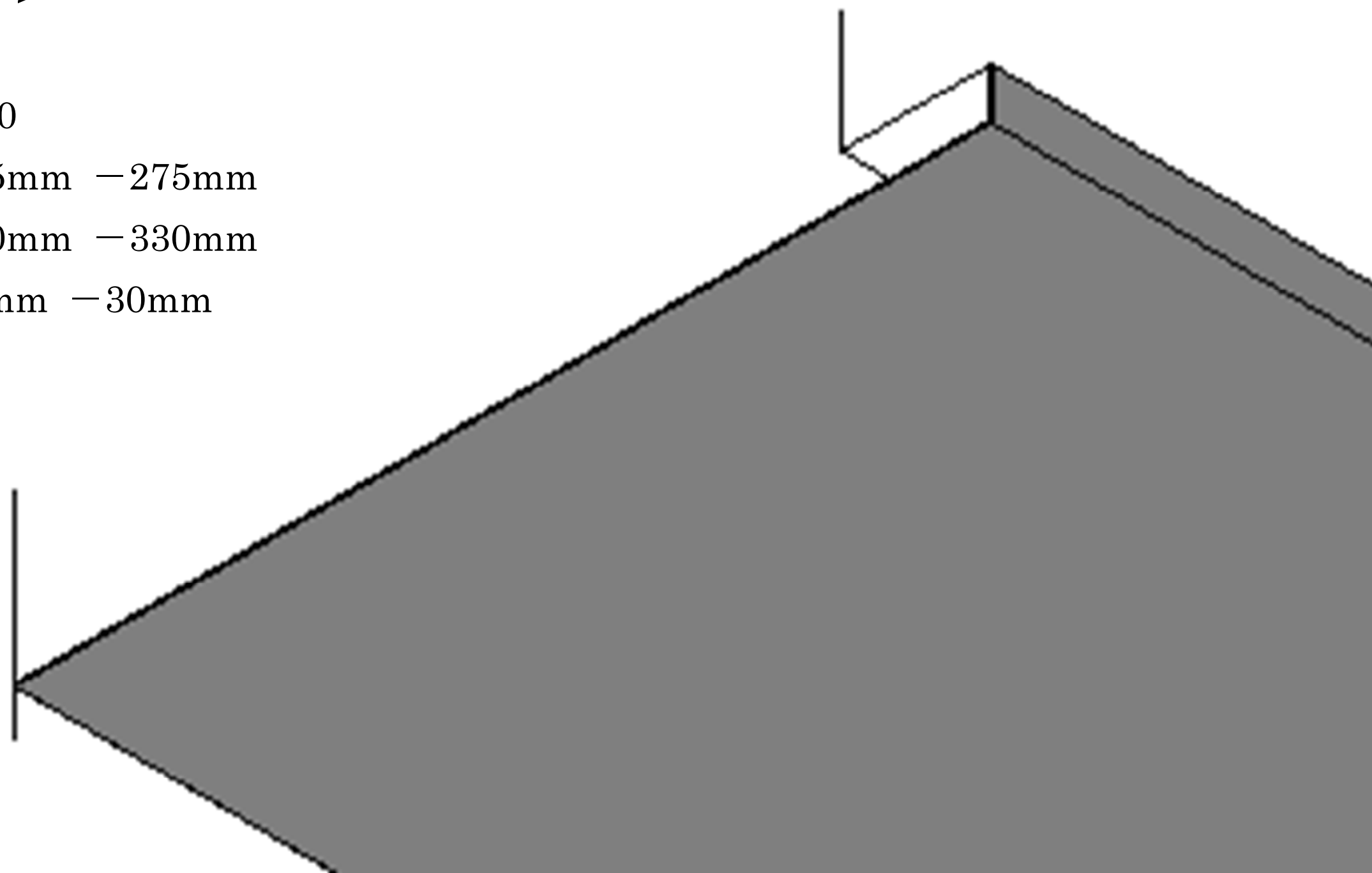

LOD250

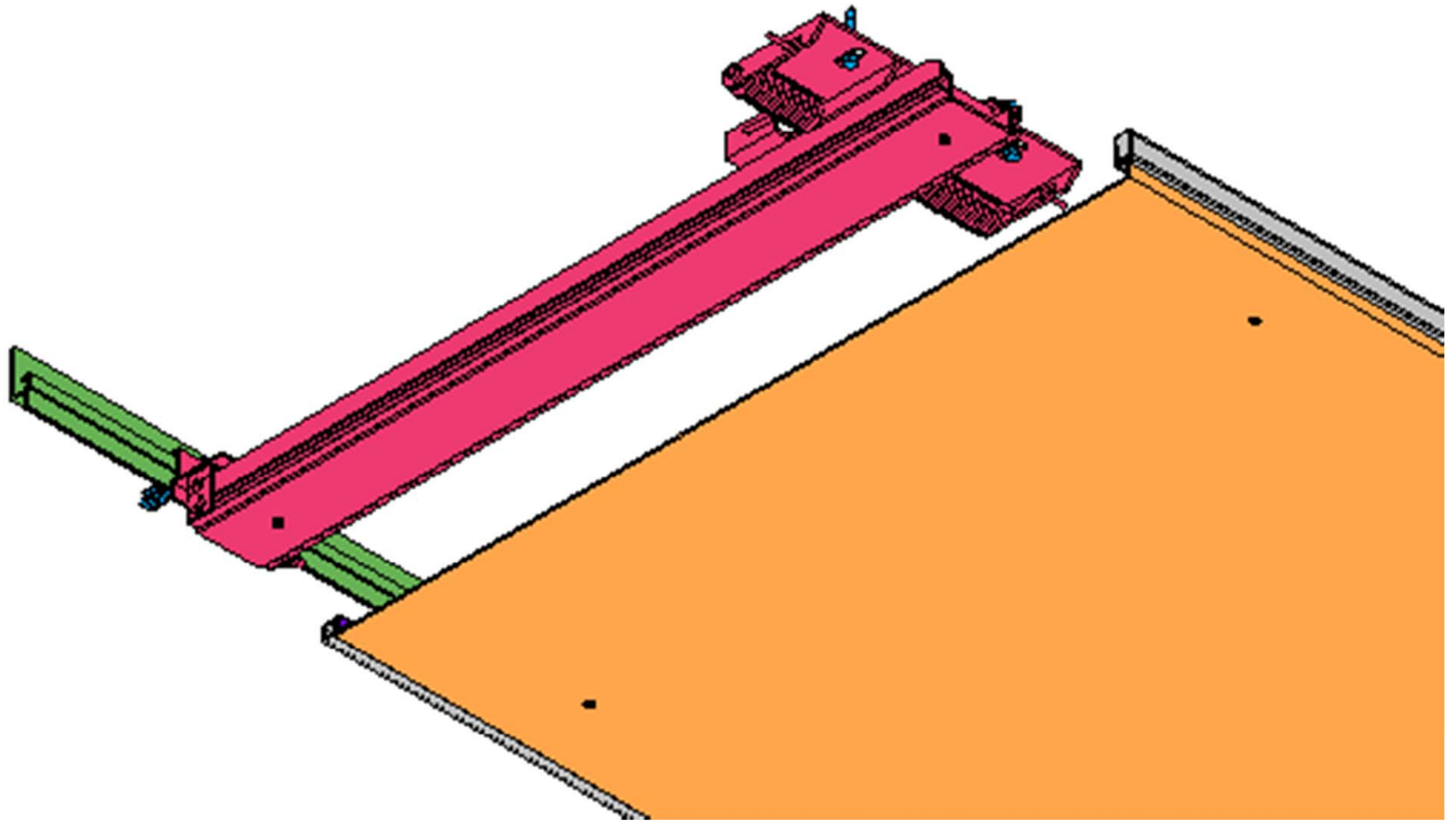

LOD400

| | | | | | |
|--------|-----------|--------|-------------------------|-------------------------|--------|
| 天井コーナー | SL-550HTC | 種別：アルミ | 定尺2m 固定ピッチ：@≦ 850 mm | 定尺3m 固定ピッチ：@≦ 900 mm | S= 1:2 |
|--------|-----------|--------|-------------------------|-------------------------|--------|

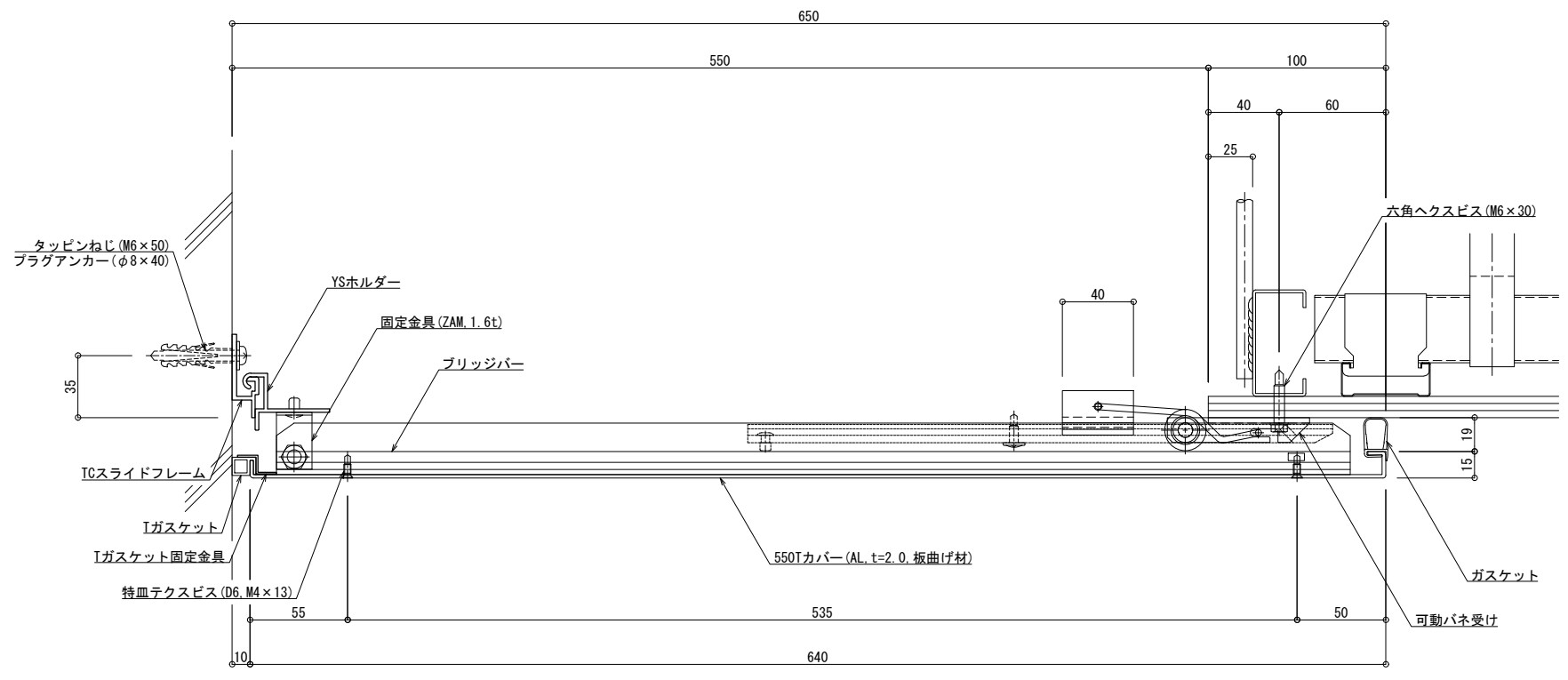

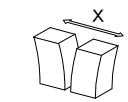
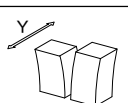
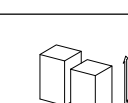
| 可動図 | 可動量 |
|---|------------------|
|  | +375mm -275mm |
|  | +330mm -330mm |
|  | +30mm -30mm |

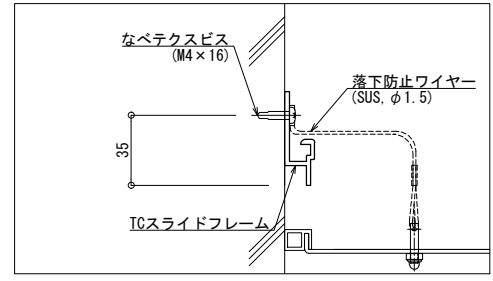

制定: 2017.9.20
 改訂: 2023.03.31