

■	天井 - 天井	SL-S100T	種別： ステンレス 仕上げ： HL	アンカー固定間隔： @ ≤ 560 mm	S= 1:2
---	---------	----------	----------------------	-------------------------	--------

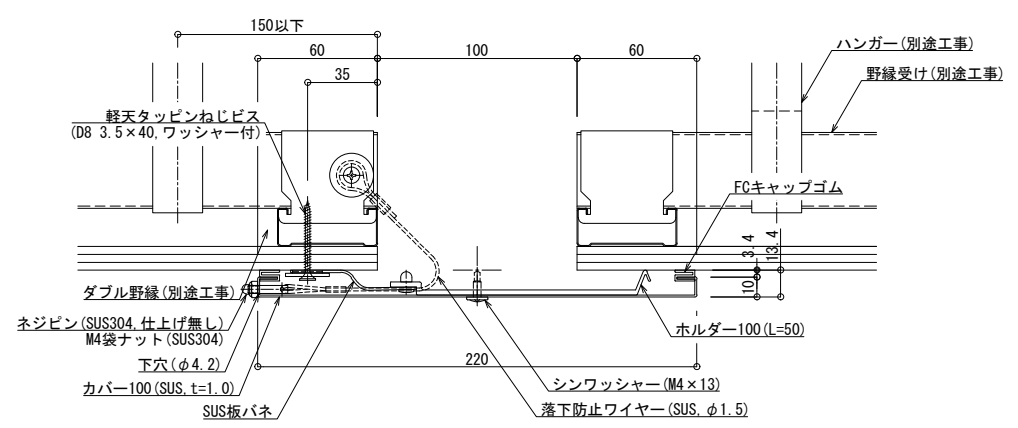
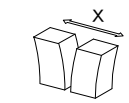
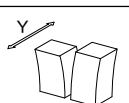
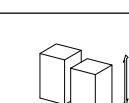

可動図	可動量
	+60mm -100mm
	+フリー -フリー
	+フリー -35mm

制定: 2017.9.20
 改訂: 2021.03.15