

床 - 床 SL-SH150F (耐火仕様) 12.5mm

アンカー固定間隔 :
@ ≤ 560 mm

S= 1:2

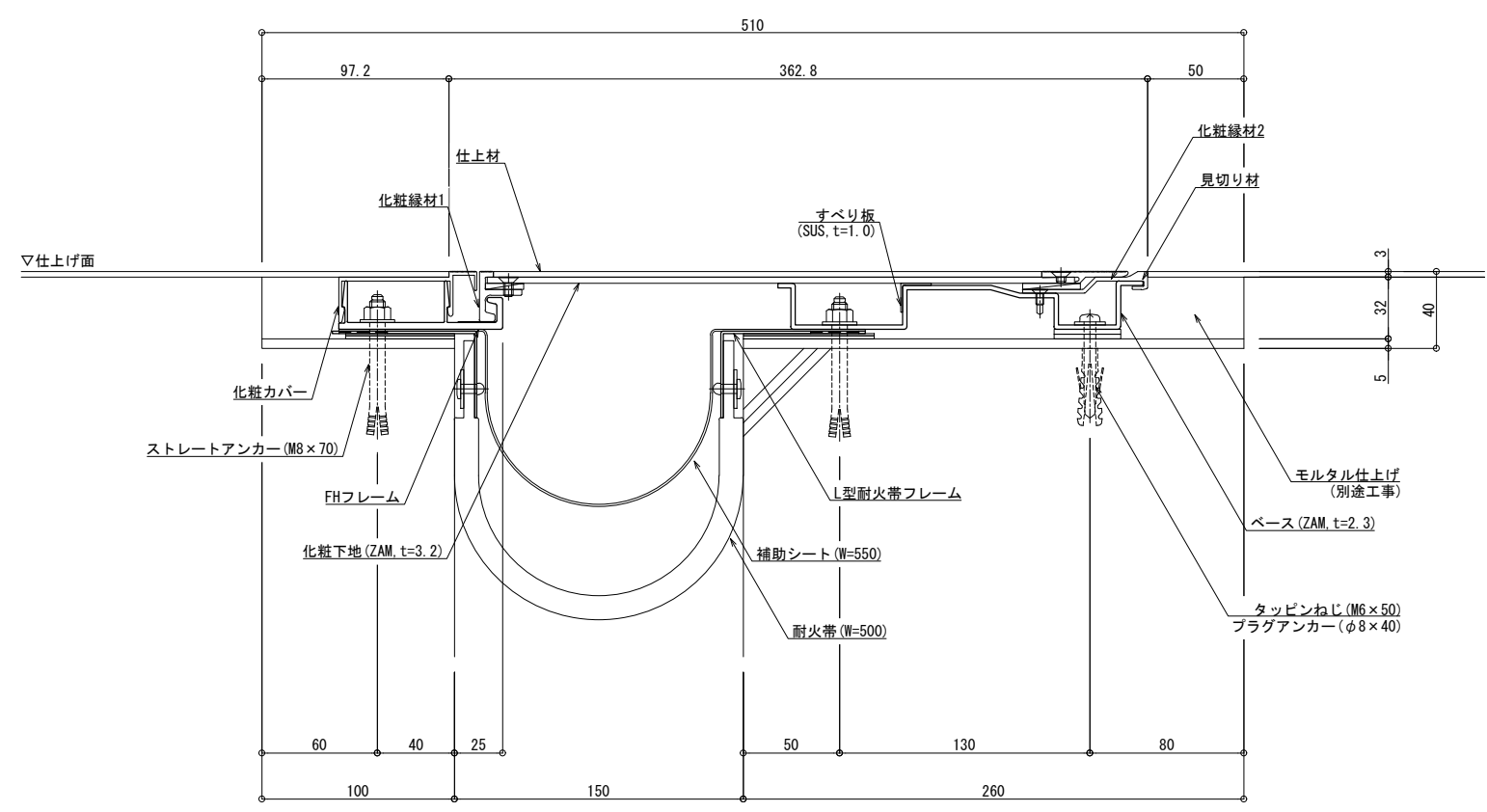
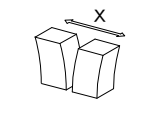
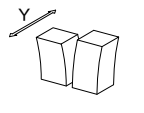
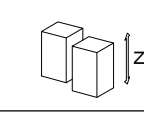

可動図	可動量
	+150mm -150mm
	+150mm -150mm
	+30mm -30mm

制定: 2017.9.20 変更: 2020.10.23