

基本断面図

A …左ページ表参照

R C

【先付タイプ】

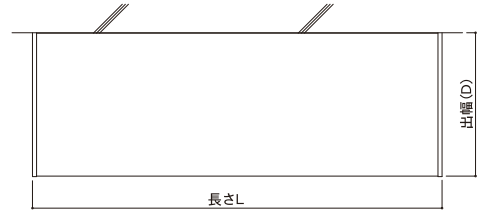
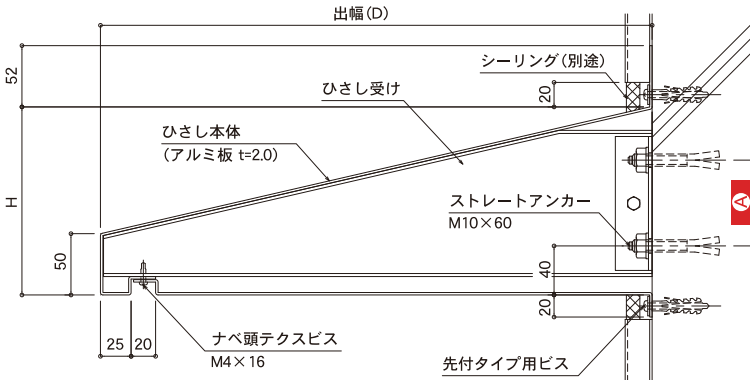

【後付タイプ】

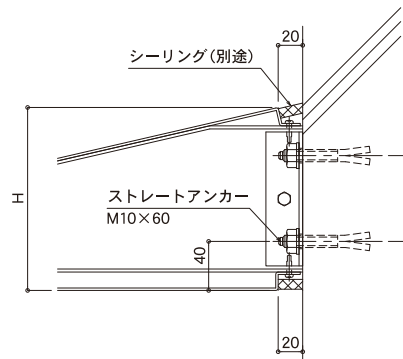

詳細納まり

ALC・押出成形セメント板

鉄骨造

木造

【先付タイプ】

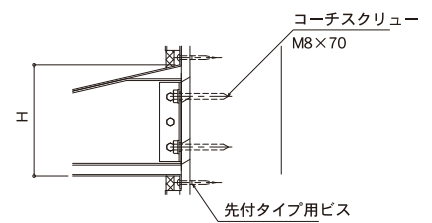
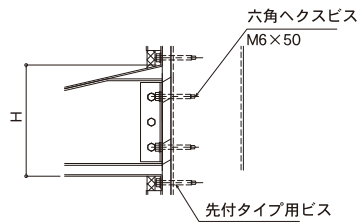
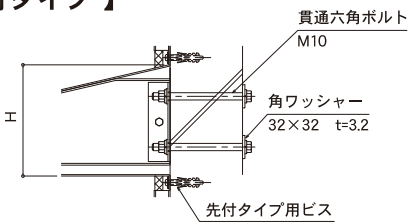

【後付タイプ】

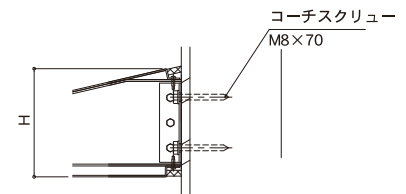
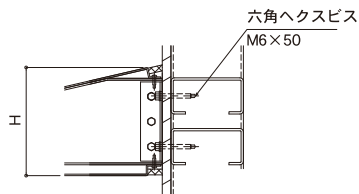
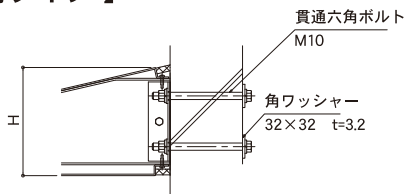

部分詳細

端部

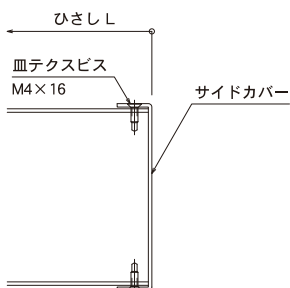

端部

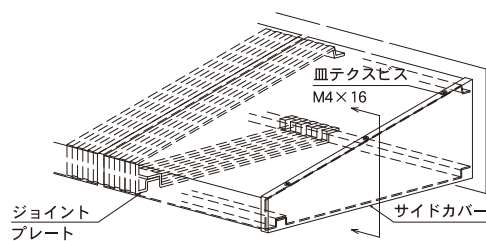

連続仕様ジョイント部

